

# Philia Sofa Collection

Design Rodolfo Dordoni

Technical Information



Philia is the new collection of outdoor sofas designed by Rodolfo Dordoni. Distinctive elements such as the generous dimensions, modularity and teak are clear references to the yachting world. The perimeter frame works both as a support for the backrests and as a tabletop, alternating with the comfortable seating. The backrests and armrests of Philia are lightly padded and can recline in three positions, increasing the possible variations. The armrest can also be used as a backrest or headrest: formal versatility, relaxation and great comfort. The supporting structure is the carabottino, the wooden grating typically used in yachts, the soul of this living furniture proposal in certified natural teak wood, which develops from the coffee table to the seats and outdoor sofa, up to more generous dimensions for the double chaise longue.

## TECHNICAL INFORMATION

### DESCRIPTION

Sofa composition for outdoor use.

### STRUCTURE

Teak.

### SEAT SUPPORT

Batyline.

### FEET

Powder coated stainless steel.

### BACKREST

Teak.

### BACKREST SUPPORT

Batyline and belts.

### CUSHIONS

Standard or hydro draining.

### STORAGE COVER

Available.

## Materials

### STRUCTURE



Teak

### FEET



Smoke

### BATYLINE + BELT



Grey+Grey



Sand+Sand

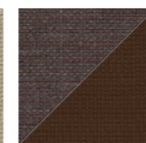

Brown+  
Brown

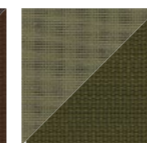

Olive+Olive



Navy+Blue

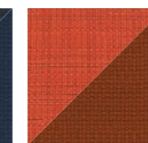

Ginger+  
Orange

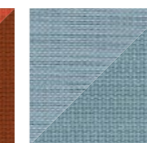

Sky+Sky

# Philia Sofa Suggested Composition

Design Rodolfo Dordoni

Technical Information

PHILIA

MAIN SUGGESTED COMPOSITION

## 201 2-SEATER LEFT MODULE

W 198 x D 115 x H 20 cm  
Seat with cushion H 35 cm

W 77" 7/8 x D 45" 1/4 x H 7" 7/8  
Seat with cushion H 13" 3/4

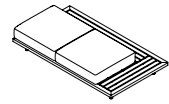

## 202 2-SEATER RIGHT MODULE

W 198 x D 115 x H 20 cm  
Seat with cushion H 35 cm

W 77" 7/8 x D 45" 1/4 x H 7" 7/8  
Seat with cushion H 13" 3/4

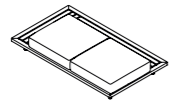

## 203 2-SEATER LEFT DECK MODULE

W 230 x D 115 x H 20 cm  
Seat with cushion H 35 cm

W 90" 1/2 x D 45" 1/4 x H 7" 7/8  
Seat with cushion H 13" 3/4

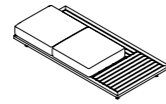

## 204 2-SEATER RIGHT DECK MODULE

W 230 x D 115 x H 20 cm  
Seat with cushion H 35 cm

W 90" 1/2 x D 45" 1/4 x H 7" 7/8  
Seat with cushion H 13" 3/4

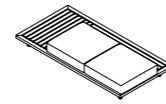

## 210 2-SEATER SOFA MODULE

W 230 x D 115 x H 20 cm  
Seat with cushion H 35 cm

W 90" 1/2 x D 45" 1/4 x H 7" 7/8  
Seat with cushion H 13" 3/4

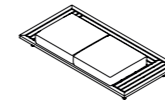

## 301 3-SEATER LEFT MODULE

W 281 x D 115 x H 20 cm  
Seat with cushion H 35 cm

W 110" 5/8 x D 45" 1/4 x H 7" 7/8  
Seat with cushion H 13" 3/4

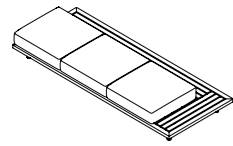

## 302 3-SEATER RIGHT MODULE

W 281 x D 115 x H 20 cm  
Seat with cushion H 35 cm

W 110" 5/8 x D 45" 1/4 x H 7" 7/8  
Seat with cushion H 13" 3/4

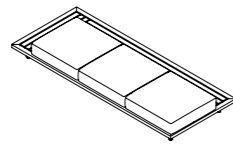

## 303 2-SEATER LEFT DECK MODULE

W 313 x D 115 x H 20 cm  
Seat with cushion H 35 cm

W 123" 1/4 x D 45" 1/4 x H 7" 7/8  
Seat with cushion H 13" 3/4

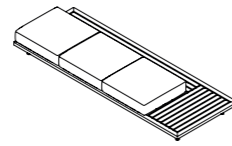

## 304 2-SEATER RIGHT DECK MODULE

W 313 x D 115 x H 20 cm  
Seat with cushion H 35 cm

W 123" 1/4 x D 45" 1/4 x H 7" 7/8  
Seat with cushion H 13" 3/4

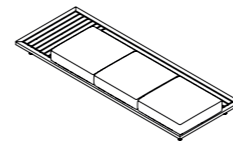

## 310 3-SEATER SOFA MODULE

W 313 x D 115 x H 20 cm  
Seat with cushion H 35 cm

W 123" 1/4 x D 45" 1/4 x H 7" 7/8  
Seat with cushion H 13" 3/4

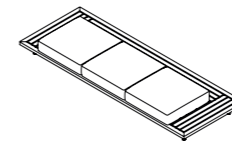

## 400 2-SEATER CENTRAL CHAISE LONGUE

W 281 x D 115 x H 20 cm  
Seat with cushion H 35 cm

W 110" 5/8 x D 45" 1/4 x H 7" 7/8  
Seat with cushion H 13" 3/4

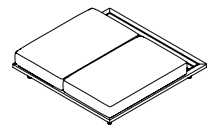

## 401 1-SEATER LEFT CHAISE LONGUE

W 166 x D 115 x H 20 cm  
Seat with cushion H 35 cm

W 65" 1/2 x D 45" 1/4 x H 7" 7/8  
Seat with cushion H 13" 3/4

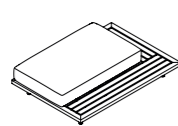

## 402 1-SEATER RIGHT CHAISE LONGUE

W 166 x D 115 x H 20 cm  
Seat with cushion H 35 cm

W 65" 1/2 x D 45" 1/4 x H 7" 7/8  
Seat with cushion H 13" 3/4

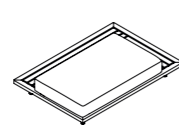

## 900 COFFEE TABLE

W 115 x D 115 x H 20 cm

W 45" 1/4 x D 45" 1/4 x H 7" 7/8

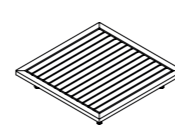

## 101 BACKREST/ARMREST

W 69 x D 17 x H 53 cm

W 27" x D 6" 3/4 x H 20" 7/8



## DETAILS

The backrest/armrest is reclining in 3 positions and can be positioned on the module deck at each seat.

Lo schienale/bracciolo è reclinabile in 3 posizioni e può essere posizionato sul deck dei moduli in corrispondenza di ogni seduta.

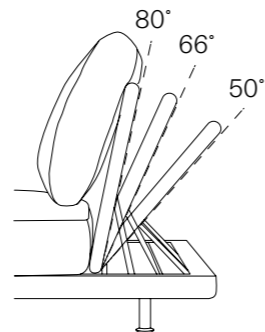
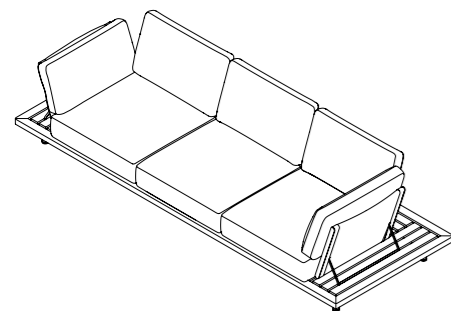

# Philia Sofa Suggested Composition

Design Rodolfo Dordoni

Technical Information

PHILIA

MAIN SUGGESTED COMPOSITION

## PHILIA SOFA COMPOSITION

1 x PHILIA 310 3-seater sofa module  
5 x PHILIA 101 backrest



## PHILIA SOFA COMPOSITION

1 x PHILIA 304 3-seater right deck module  
1 x PHILIA 401 1-seater left chaise longue  
4 x PHILIA 101 backrest

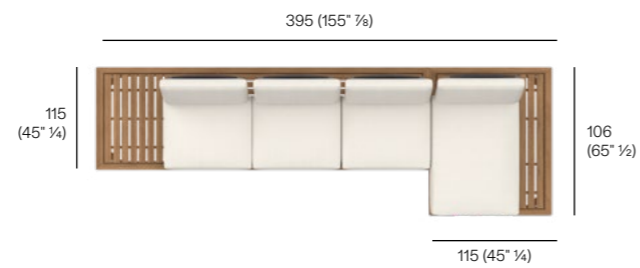

## PHILIA SOFA COMPOSITION

1 x PHILIA 210 2-seater sofa module  
1 x PHILIA 201 2-seater left module  
5 x PHILIA 101 backrest

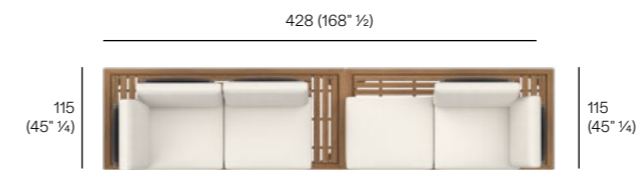

## PHILIA SOFA COMPOSITION

1 x PHILIA 210 2-seater sofa module  
1 x PHILIA 400 2-seater central chaise longue  
5 x PHILIA 101 backrest

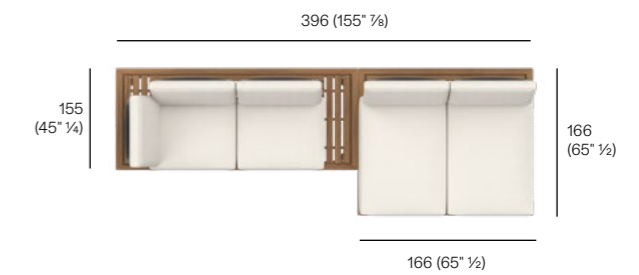

## PHILIA SOFA COMPOSITION

1 x PHILIA 204 2-seater right deck module  
1 x PHILIA 202 2-seater right module  
1 x PHILIA 302 3-seater right module  
6 x PHILIA 101 backrest

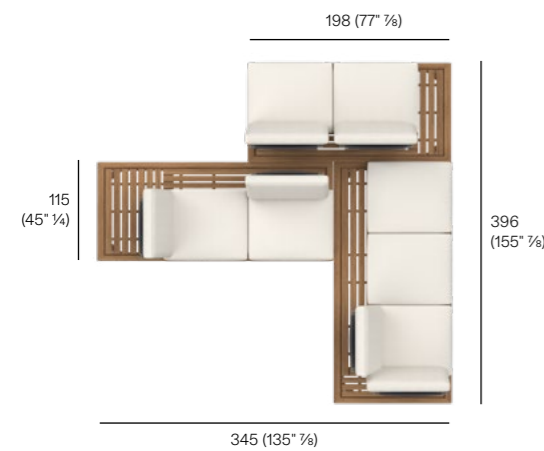

## PHILIA SOFA COMPOSITION

1 x PHILIA 204 2-seater right deck module  
1 x PHILIA 301 3-seater left module  
1 x PHILIA 201 2-seater left module  
6 x PHILIA 101 backrest

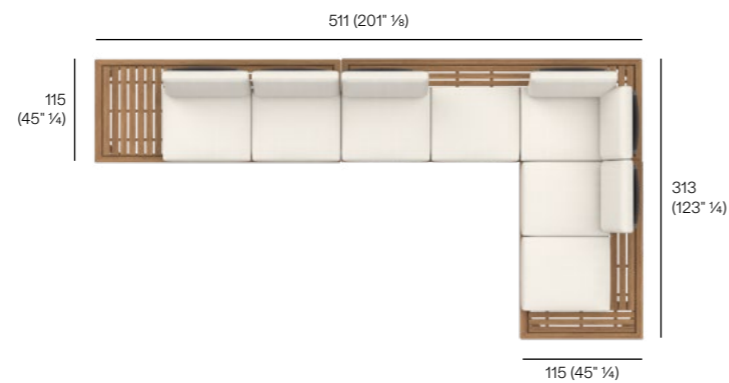

## PHILIA SOFA COMPOSITION

2 x PHILIA 204 2-seater right deck module  
1 x PHILIA 302 3-seater right module  
7 x PHILIA 101 backrest

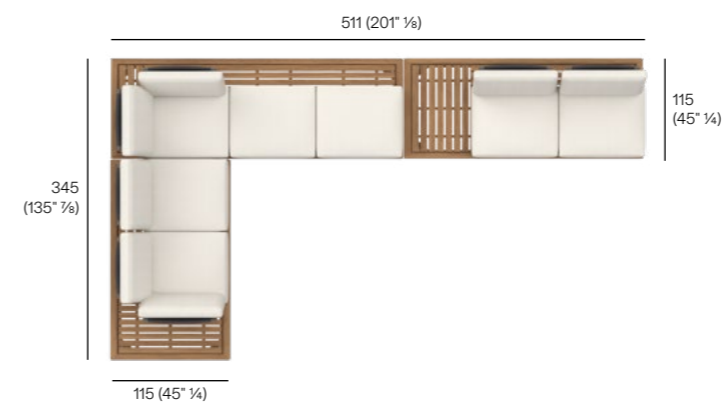

## PHILIA SOFA COMPOSITION

1 x PHILIA 204 2-seater right deck module  
1 x PHILIA 302 3-seater right module  
1 x PHILIA 900 coffee table  
1 x PHILIA 400 2-seater central chaise longue  
7 x PHILIA 101 backrest

