

DATASHEET

Type: **STARCLOUD**
Name: Pendant light
ID: US1345
Designed by: Lucie Koldová



Download

Description

These stars project a subtly different optical effect depending on the viewing angle, appearing to variably wax and wane or come to rest in a state of symmetry. Suspended on slender coaxial cables of varying lengths, the delicate handblown glass shades are available in three variants: opaque opaline, pearl pink opaline, and pearl grey opaline.

Tech. description

The light comprises a dural fixture with integrated LED module, a diffuser crafted from light-conducting material, and a glass shade. The light is suspended on a coaxial cable from a metal ceiling canopy.



CONSTRUCTION SPECIFICATION

Weight: 4.4 lb
Construction material: glass, metal
Cord length [in]: 86.6
Mounting: Ceiling
Environment: Dry

DIMENSIONS [in]

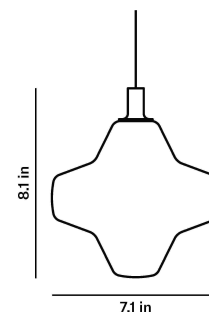

ELECTRICAL SPECIFICATION

Input voltage [V]: 100 - 240 V
Frequency [Hz]: 50-60 Hz
Max. power [W]: 3 W
Coverage IP: 20
Socket: -
Light source: LED module
Energy class: E

CERTIFICATIONS



BROKIS®

BROKIS S.R.O.
ŠPANILOVA 1315/25
163 00 PRAHA 6 - ŘEPY
CZECH REPUBLIC

ORG ID 64940799
VAT ID CZ64940799
C 42174 MĚSTSKÝ SOUD
V PRAZE

TEL +420 567 211 517
TECHNICAL@BROKIS.CZ
INFO@BROKIS.CZ
WWW.BROKIS.CZ

2024_03
PAGE 1



CM17826 LED modul 2,5W 24VDC
optic 60° 2700K PCB5050 2.524 927

Type	LED module
Lamp wattage [W]	2,5 W
Input voltage [V]	24 VDC
Energy class	E
Flux [lm]	250 lm
Light colour [K]	2700 K
CRI	90+
Dimmable	yes





INNER FIXTURE

Dimensions O x w [in] 1.15 x 6.5 in
Weight [lb] 2.2 lb
Material metal

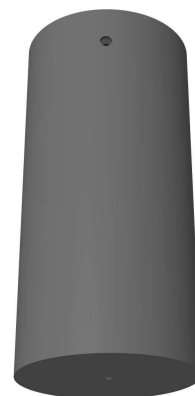

Drawing

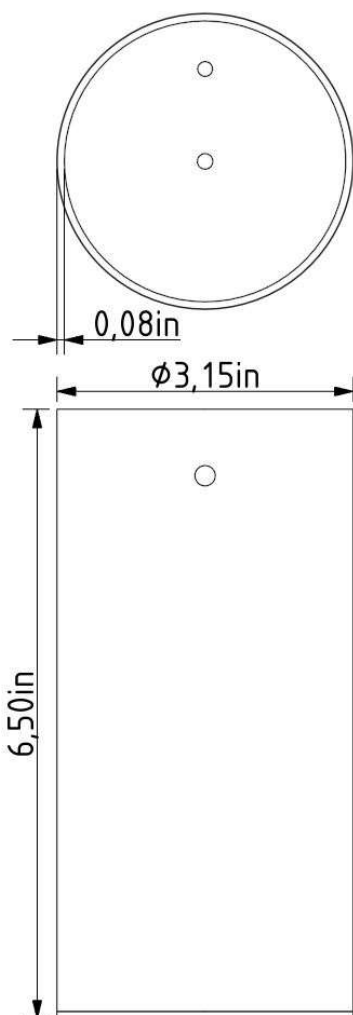

Hole placement

