



LOUIS XIV

Daide Groppi / 2023

Louis XIV is the freakiest letter of our light alphabet.
It's a disobedient design that translates a certain rebellion
to common lamp models into light.
I wanted to investigate the idea of the chandelier: in line with our poetics,
Louis XIV is the only possible solution for lightness and irony.
Dimmable suspension lamp with double emission.

Louis XIV è la lettera più "freak" del nostro alfabeto luminoso.
È un progetto disobbediente, che traduce in luce una certa ribellione
ai modelli comuni di fare lampade.
Volevo affrontare il tema del lampadario a gocce:
Louis XIV è l'unica soluzione possibile, secondo le nostre poetiche, tra leggerezza e ironia.
Lampada a sospensione dimmerabile a doppia emissione.

LOUIS XIV

Davide Groppi / 2023

Suspension / Direct-Indirect / Indoor

Material Glass - Metal
Finish .19 Polished Gold

Note Suspension luminaire. Eighty crystal drops and a bird. Natural brass branches. Structure with polished gold finish. Matt white rose. Dual emission and on/off. White cable. LOUIS XIV 2: version with power cable only and without rose. *Apparecchio illuminante a sospensione. Ottanta gocce in cristallo e un uccellino. Rami in ottone naturale. Struttura con finitura oro lucido. Rosone bianco opaco. Doppia emissione ed accensione. Cavo bianco. LOUIS XIV 2: versione con solo il cavo di alimentazione e senza rosone.*

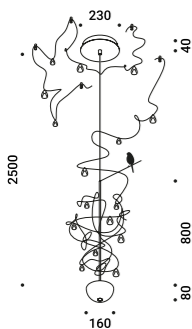

LOUIS XIV 1

Ceiling driver version
 16,5W
 110-240V - 50/60Hz
 2700K - Up 890lm - Down 210lm /
 3000K - Up 936lm - Down 235lm
 CRI >90
 Down UGR <19
 Driver integrated
 TRIAC/IGBT
CE IP20

Polished Gold - 2700K - TRIAC/IGBT | 1A4361900.27.02
 Polished Gold - 3000K - TRIAC/IGBT | 1A4361900.30.02

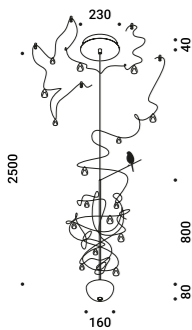

LOUIS XIV 1

Ceiling driver version
 16,5W
 110-240V - 50/60Hz
 2700K - Up 890lm - Down 210lm /
 3000K - Up 936lm - Down 235lm
 CRI >90
 Down UGR <19
 Driver integrated
 DALI - PUSH - 1-10V
CE IP20

Polished Gold - 2700K - DALI - PUSH - 1-10V | 1A4361900.27.07
 Polished Gold - 3000K - DALI - PUSH - 1-10V | 1A4361900.30.07

Davide Groppi / 2023

LOUIS XIV

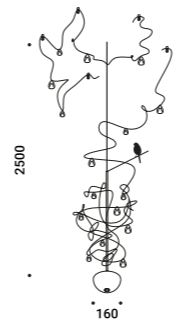

LOUIS XIV 2

Remote driver version
 15W
 Max 250mA DC
 2700K - Up 890lm - Down 210lm /
 3000K - Up 936lm - Down 235lm
 CRI >90
 Down UGR <19
 Driver not included
 2 Drivers required
CE IP20

Polished Gold - 2700K | 1A4361900.27.20
 Polished Gold - 3000K | 1A4361900.30.20

Compulsory accessories / Accessori obbligatori

Drivers / Alimentatori

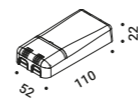

Driver / Alimentatore			Not included
220-240V(110-127V)	250mA/13,5W(13,5W)/IP20/DALI - PUSH LOUIS XIV 2 - 1-10V	1Z0241270.250	

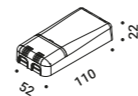

Driver / Alimentatore			Not included
220-240V	250mA/12,5W/IP20/TRIAC/IGBT LOUIS XIV 2	1Z0241280	

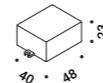

Driver / Alimentatore			Not included
220-240V	250mA/4,2W/IP20/TRIAC/IGBT LOUIS XIV 2	1Z2320010	

Optional accessories / Accessori opzionali

Suspension kits / Kit di sospensione

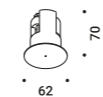

Recessed suspension kit for 12,5 mm plasterboard / Kit di sospensione da incasso per cartongesso 12,5 mm			Not included
Matt White	For electrical cables - 1 Piece Plasterboard cut-out Ø 44 mm Minimum space for mounting 70 mm	LOUIS XIV 2 1X0000300.05.00	
Matt Black	For electrical cables - 1 Piece Plasterboard cut-out Ø 44 mm Minimum space for mounting 70 mm	LOUIS XIV 2 1X0000400.05.00	

SUSPENSION KITS / KIT DI SOSPENSIONE

Recessed suspension kit / Kit di sospensione da incasso

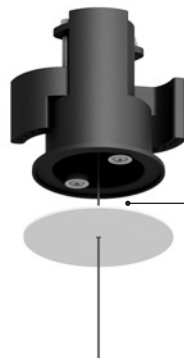
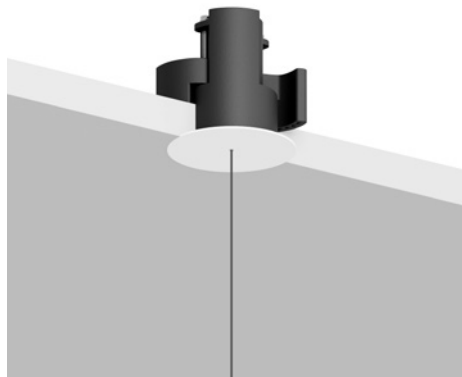

Suspension kit for 12,5 mm plasterboard
Plasterboard cut-out Ø 44 mm
Minimum space for mounting 70 mm

Kit di sospensione per cartongesso 12,5 mm
Dimensioni taglio cartongesso Ø 44 mm
Spazio minimo per incasso 70 mm

Magnetic fixing
Fissaggio magnetico

Version	Use	Product reference	Finish	Code
Recessed suspension kit.01	For suspension cables	REFLEX S 1 REFLEX S 2 SHANGHAI 1 SHANGHAI 2 SOTTILE 1 SOTTILE 1 DE SOTTILE 2 SOTTILE 2 DE	Matt White	1X0000300.01.00
			Matt Black	1X0000400.01.00
Recessed suspension kit.02	For electrical cables	MAGIA	Matt White	1X0000300.02.00
			Matt Black	1X0000400.02.00
Recessed suspension kit.03	For suspension cables	MASAI 1 MASAI 2 SPY SPY DE	Matt White	1X0000300.03.00
			Matt Black	1X0000400.03.00
Recessed suspension kit.04	For electrical cables	ASINTOTO REFLEX S 2 SHANGHAI 2 SOTTILE 2 SOTTILE 2 DE	Matt White	1X0000300.04.00
			Matt Black	1X0000400.04.00
Recessed suspension kit.05	For electrical cables	LOUIS XIV 2 SOTTOSOPRA 2	Matt White	1X0000300.05.00
			Matt Black	1X0000400.05.00



The sizes are expressed in millimeters.