

OLIVE

16.10

Design by Omer Arbel
PRODUCT SPECIFICATION

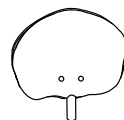
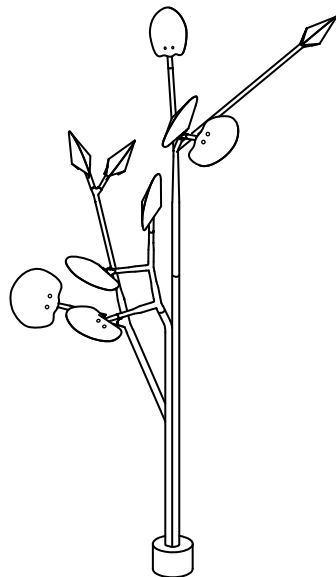

216
(8.5')



64
(2.5')

203 (8')

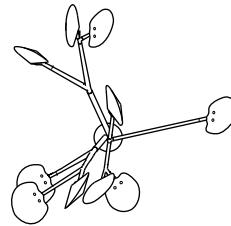

1200
(47')

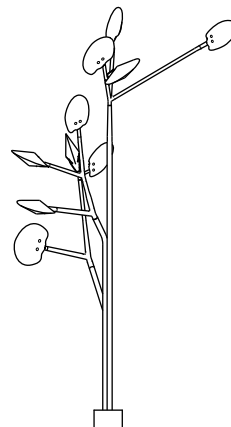

2200
(87')

150 (6')

1200 (47')

approx 55kg (121lb)

- PENDANTS: ten
- MOUNTING: 150mm (6") diameter base plate
- LAMPING: 1.5w LED (15w total draw)
- DIMMING: not dimmable
- MATERIALS: poured glass, electrical components, bead blasted stainless steel armature components
- WEIGHT: approximately 55kg (121lb)
- DRIVERS: remote

DESCRIPTION

The 16.10 is a tree-like 16 installation using ten pendants and a modular stainless steel armature system mounted to a three tube stainless steel 'olive' base. These trees are designed to be grouped into forest-like assemblies of a variety of different sizes and types, but are strong compositional elements on their own. Installation of these trees is complex and Bocci recommends a structural consultant to assess the viability of the system in the context in which it is to be installed. Installation requires anchoring into either an existing structural slab or a newly built foundation to meet the specifications of the design drawings, including appropriate drainage if exposed to water and remotely mounted LED drivers.

16 is formed by sequentially pouring three separate layers of coloured, molten glass – in varying opacities – on a horizontal plane. Each layer responds to the indeterminate shape of the previous pour to create a uniquely layered whole. Two of these pieces are then attached and illuminated with an internal LED lamp. The finished 16 is visually complex: each separate colour layer is visible through the other layers, with light reflecting along the edges.

All trees are rated for outdoor (or indoor) use based on structural analysis for moderately sheltered locations near seawater with minimal snow loads. Any other application restraints may need further engineering.

NOTES

- + Purchase replacement lamps online at www.bocci.ca/shop/bulbs
- + Pendant comes in grey 1, grey 2, white 1, or white 2. Please specify when ordering.
- + Available in a wet location configuration.
- + Drivers must be mounted remotely in an easily accessible and hidden location for ease of long-term maintenance.

CAN 16234
US patent # D754,911
EU patent #002672774 - 0001 to 0012

Made in Vancouver, Canada

Vancouver
sales@bocci.ca
www.bocci.ca

Berlin
europe@bocci.ca
www.bocci.ca

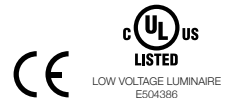

BOCCI

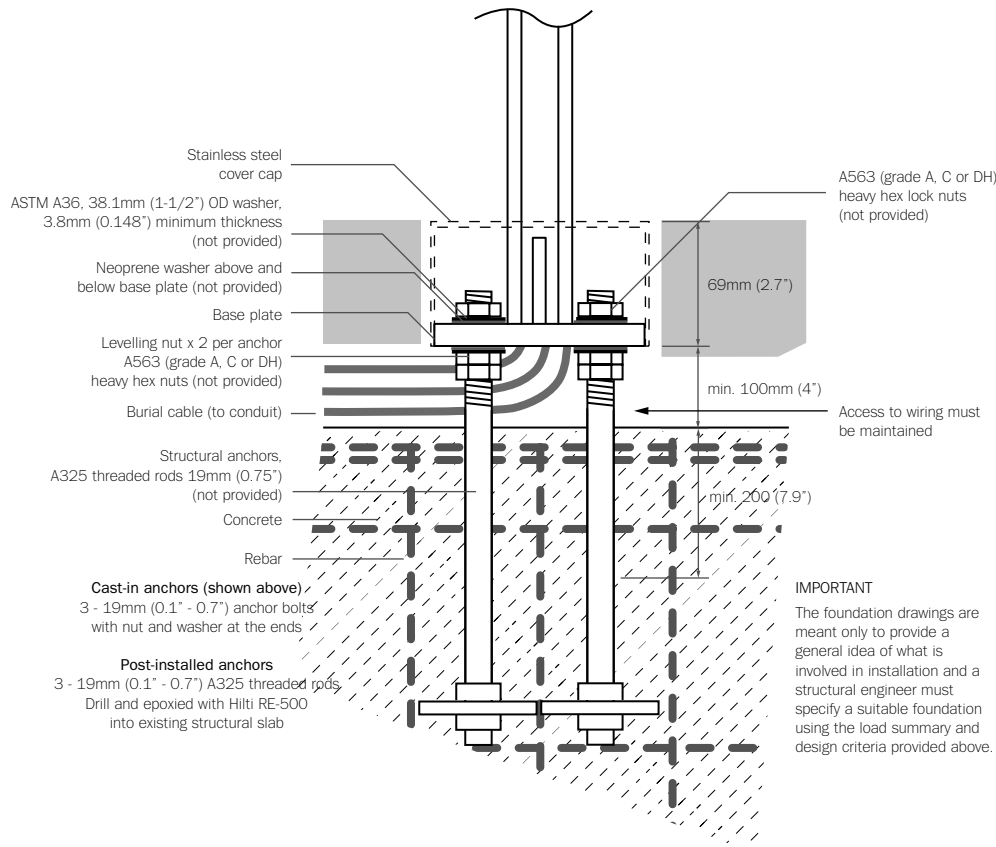
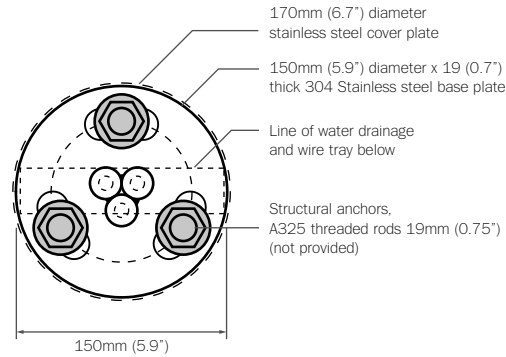

IMPORTANT
The foundation drawings are meant only to provide a general idea of what is involved in installation and a structural engineer must specify a suitable foundation using the load summary and design criteria provided above.

PENDANTS:	DL: 23N (5.3lbs)
MAX UNFACTORED WIND SPEED:	21 m/s
MAX UNFACTORED SNOW / ICE LOAD:	6 N /pendant
UNFACTORED SEISMIC LOAD:	305N HORIZONTAL @ 1500mm ABOVE BASE CONNECTION
FACTORED DESIGN LOAD FOR BASE CONNECTION:	Mf: 2 kN*m Vf: 1 kN

LOAD SUMMARY & DESIGN CRITERIA

Installation of these trees is complex and Bocci recommends a structural consultant to assess the viability of the system in the context in which it is to be installed. Installation requires anchoring into either an existing structural slab or a newly built foundation to meet the specifications of the design drawings, including appropriate drainage if exposed to water and remotely mounted LED drivers.

Anchoring of these trees is critical and it is imperative that the assembly drawings are followed. The foundation and fixing of anchors to the foundation are the responsibility of the client. Drawings are provided only to give a general idea of what is involved in installation for early phase design development. The trees are designed for the load assumptions above and should not be installed in a location where any of those design forces will be surpassed. Neglecting the design forces may lead to failure of the structure. The design of a suitable foundation is to be provided by a structural engineer.

The modular trees will deflect under wind loading. All modular tree components should be kept at least 600mm (23.6 inches) away from any other object to allow space for the tree to deflect without causing damage to other objects.

For our purposes, and due to specific site constraints that will guide the preparation of the site, the installation instructions begin with the anchors already installed.

MAINTENANCE

As with all outdoor fixtures, Bocci outdoor armature (tree) installations should be specified with the expectation that general maintenance will be required over the lifetime of the fixture. We recommend cleaning and maintaining the luminaries and armature regularly. In addition to the necessity of general maintenance, armature replacement parts may be required over time due to the nature of outdoor exposure. Bocci's two year product warranty on armature parts is applicable to these replacement parts, excluding any labour costs incurred by the client.

The armature is constructed of stainless steel that has been sandblasted to attain a matte finish. As a result, the stainless steel will react differently than polished stainless steel in some environments. Finishes for fixtures installed outdoors are subject to change and naturally mature over time due to prolonged exposure to sunlight, pollutants and other environmental conditions. Bocci recommends that all armature installed in an outdoor setting be coated on site with a protective oil or paint finish to provide a barrier between the steel parts and any environmental elements that can cause corroding. The choice of an oil or paint finish will depend on the desired aesthetic and the severity of the environment and its effect on metal finishes. This coating will need to be maintained over the lifetime of the installation to protect against the natural corrosion of metal.

All Bocci armature fixtures are engineered for temperate climates and the level of maintenance will increase if the installation is located in a particularly extreme climate i.e. extreme temperatures, high humidity, high salinity, snow, sand storms, heavy rain, ice, etc.

Coastal environments: The environment of a sea coast can be extremely corrosive. Even with appropriate maintenance, products installed in a coastal environment will typically deteriorate more than products installed in a more moderate environment. Some corrosion and/or deterioration is considered normal wear in this environment. Thus, any claim for finish failures or for corrosion due to coastal environment conditions is not applicable to the product warranty.

OLIVE

16.10

Design by Omer Arbel
PRODUCT INSTALLATION INSTRUCTIONS

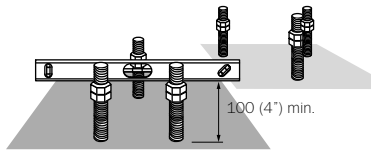

1

With the anchors in place, spin two of the provided nuts followed by a washer onto each anchor. Ensuring a minimum of 100mm (4") from top of leveling nuts to ground, use a level and level off 4 sets of nuts (hardware not provided).

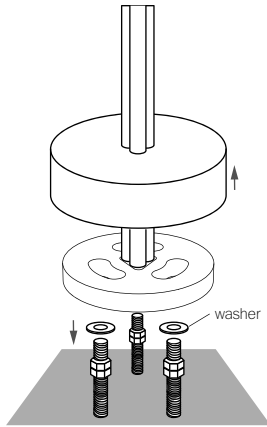

2

Place washer on each anchor.
Lift off the cover.

Using heavy equipment (if necessary), lower the tree base onto the anchor keeping the pull wire free for the following steps. Repeat this step for all nearby trees.

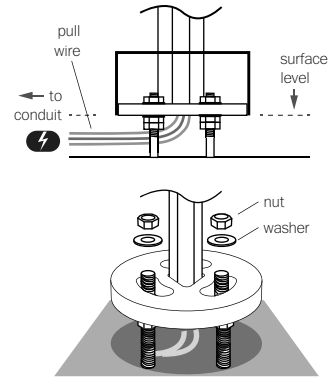

3

Orient the tree base in the direction you want the branches to go.

Once all tree bases are in place, put another washer on each anchor followed by a nut and tighten the nuts until snug.

Note: Make sure that the area under the base is kept clear and the pull wire does not get damaged during install.

Do not in-fill this area under the base. Wires must be kept free, even after final install.

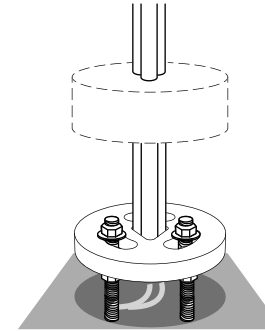

4

Once all wiring connections are complete, and the nuts are snug-tight, slide the cover cap down over the plate until it rests on either the gussets or the ground.

Note: Bocci recommends installing the finish floor height higher than the cover cap with a small reveal around the tree base or alternately installing flush with the cover plate.

Depending on the final installation aesthetic, you may want to finish the floor at this point if the finished floor can support a lift or scaffold for installation of the pendants. If not, complete steps 6-8 before finishing the mount detail.

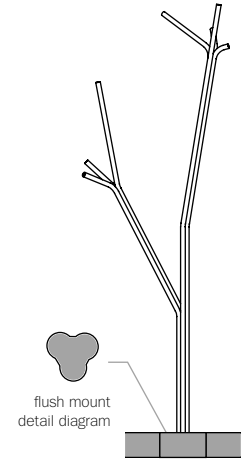

5

You should now have an upright tree base ready for composition of the pendants according to the specification sheet.

OLIVE

16.10

Design by Omer Arbel
PRODUCT INSTALLATION INSTRUCTIONS

© 2019, Bocci Design and Manufacturing Inc. All rights reserved. Any inquiries should be directed to: info@bocci.ca

BOCCI

2017-11

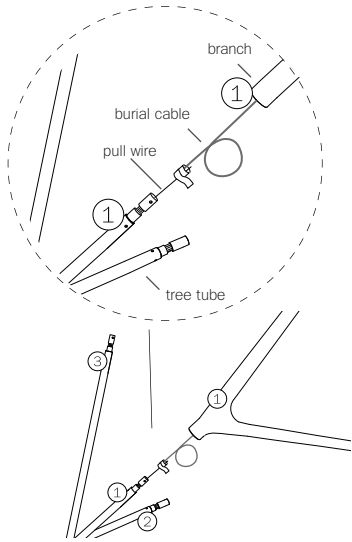

6

Matching the branch number with the tree tube number, secure the burial cable of each branch to the end of the pull wire with tape or other temporary means.

Ensure burial cable still fits freely through the tree tube.

Turn power to fixture on.

Note: Test each branch to ensure all LEDs light before attaching to tree.

Please check Exploded view instruction for assembly details.

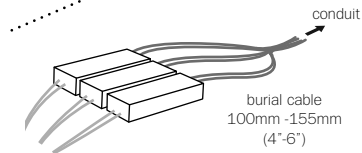
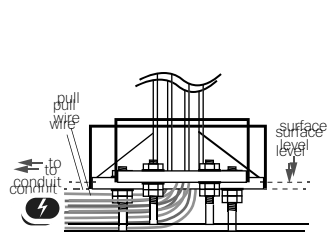

7

After each branch is installed, feed pull wire through pre-laid conduit to the driver (power supply) location.

Connect burial cables to drivers (power supplies), ensuring to leave 100-155mm (4'-6") of loose excess burial cable.

Check that each lamp is working properly as you go along.

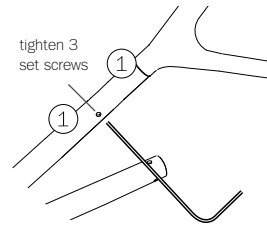

8

Orient branches as desired, ensuring there is no interference with adjacent branches, pendants or trees.

Tighten set screws to secure the branch.

Remove the metal tube at the end of each branch by unscrewing the set screw.

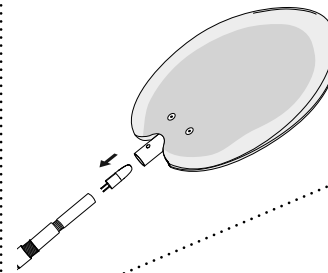
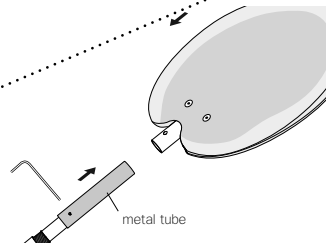

9

Plug the lamp into lamp socket. Ensure power to lamp is working correctly.

Slide the pendant onto the branch, orient as desired, and secure using an M4 set screw (provided).

Note: If the fixture sags or seems unbalanced you may be overloading the base. Remove pendants, or shorten cantilever as required.

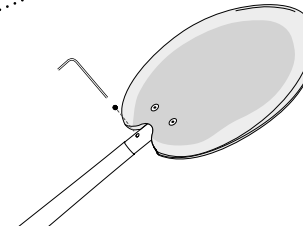

10

Clean fingerprints from pendants.

For additional assistance, please contact Bocci:

Vancouver
sales@bocci.ca
www.bocci.ca

Berlin
europe@bocci.ca
www.bocci.ca

CAN 16234
US patent # D754,911
EU patent #002672774 - 0001 to 0012

Made in Vancouver, Canada

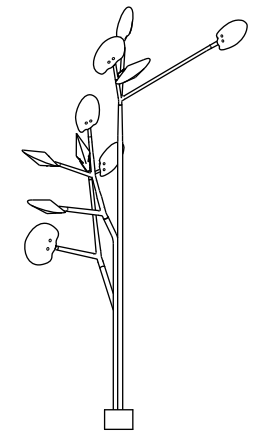

OLIVE

16.10

Design by Omer Arbel
PRODUCT INSTALLATION INSTRUCTIONS

© 2019, Bocci Design and Manufacturing Inc. All rights reserved. Any inquiries should be directed to: info@bocci.ca

BOCCI



LOW VOLTAGE LUMINAIRE
E04386

2019-11

Exploded View

Parts	Qty
16 pendant	10
AS-TB-OL3	1
AR-B-3A	1
AR-B-3B	1
AR-B-4B	1
M5	9
M4	10
Tool (M4/M5)	1

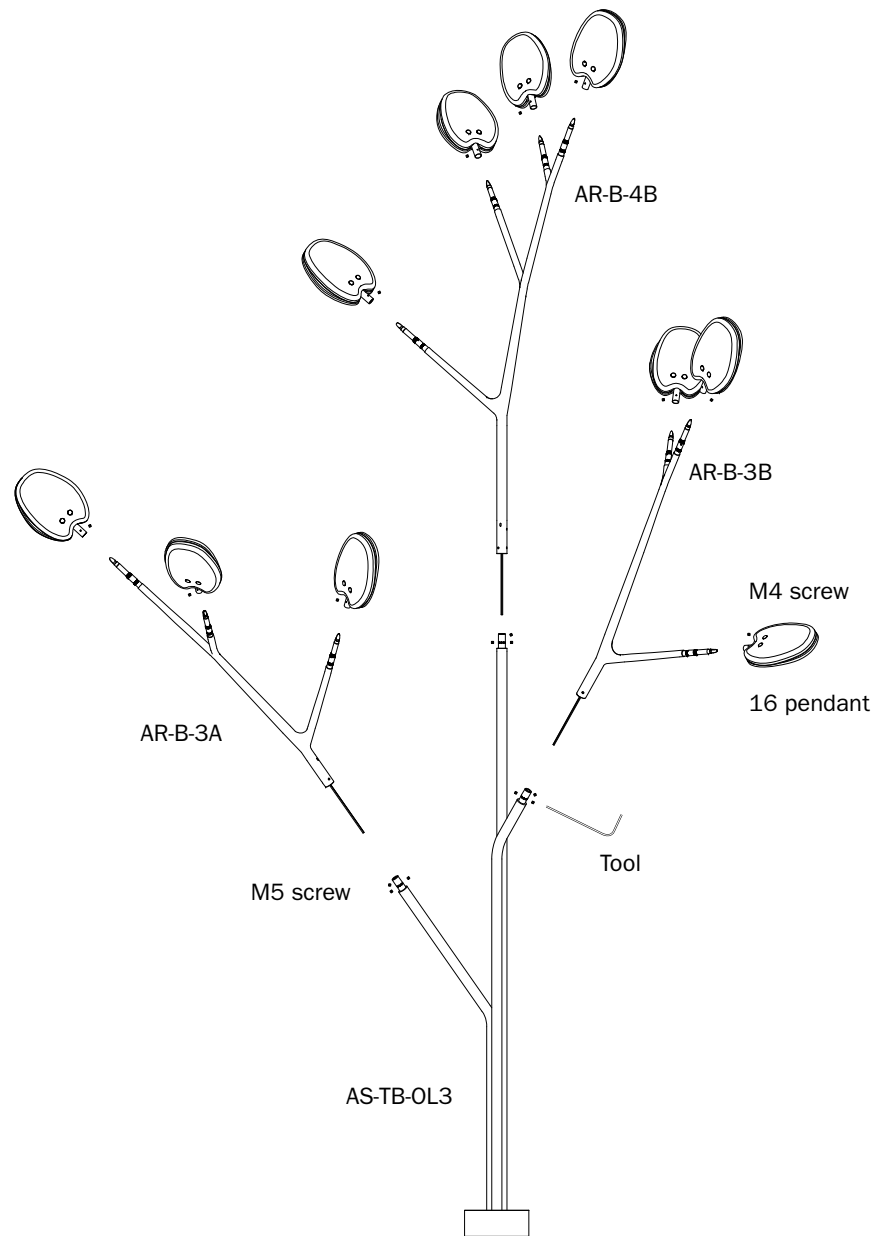

OLIVE

16.10

Design by Omer Arbel
PRODUCT INSTALLATION INSTRUCTIONS

© 2019, Bocci Design and Manufacturing Inc. All rights reserved. Any inquiries should be directed to: info@bocci.ca

BOCCI