

m o o o i[®]



Container Table 7143

by Marcel Wanders

Designer	Marcel Wanders
Year of design	2001
Material	Container Foot: PE, Top: HPL, LPL, Laquered Wood, Stained Wood, Linoleum

The container Tops are available in the following materials and colours:



HPL, A flat panel based on thermosetting resins, homogeneously reinforced with woodfibres and manufactured under high pressure and at high temperatures:

Thickness top 1.2cm | 0.5"

Also for outdoor use

Available in white, black and light grey. The trim is always black.



Oak veneer, stained and lacquered:

Thickness top 4cm | 1.6"

For indoor use only

Available in the 6 Moooi stain colours, and 25 Moooi Ral Colours



Linoak:

Thickness top, 4cm | 1.6"

For indoor use only

The solid oak edge is available in the 6 Moooi stain colours, the linoleum centre is available in Mauve, Pewter and Nero.

The container feet are available in the following shapes and colours



Classic: White, Black



New Antiques: White, Black, Brown, Light-Grey





Bodhi Cover: Black, Cinnamon, Grey, Natural Oil, Wenge, White Wash

Container General

The container table top range all attached to the container foot in the same way. The container concept is that sand, pebbles or water can be added to the foot to give it strength and stability. Water must always be treated with an anti-algae additive to prevent the water from becoming stale. There are Hex-bolts on the underside of each table which align with equally spaced holes in the container foot.

Container Table 7143 options

CONTAINER FAMILY		Top			FOOT	dining table
						7143 71cm 28" x 43cm 16.9 "
					<i>Classic</i>	
						7143 71cm 28" x 43cm 16.9 "
					<i>Bodhi</i>	
Shape	L	W	HPL	Wood	Linoak	 7143 71cm 28" x 43cm 16.9 "
					<i>New Antiques</i>	
						Number of feet required
Oval	260cm 102.4"	150cm 59.1"		x	x	2
Round	∅	120cm 47.2"	x	x	x	1
Round	∅	140cm 55.1"	x	x	x	1
Square	120cm 47.2"	120cm 47.2"	x	x	x	1

HPL colours

HPL tops are available in the following colours



Black

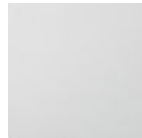

Grey

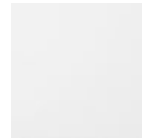

White

Linoak

The center of the Linoak top is made of linoleum, and available in the following colours. The solid oak edge is available in one of the 6 moooi stain colours.



mauve



nero



pewter

Stain colours

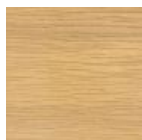

White Wash

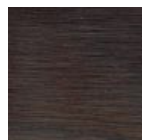

Wenge

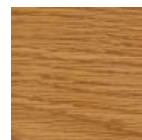

Natural Oil



Grey

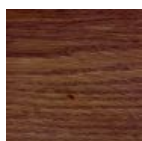

Cinnamon



Black Stained

Ral Colours

Available RAL Colours:

1004 1013 1023 1027 2000 2002 2004 3012 3015 5003 5008 5024 6010 6021 7001 7011 7035 7044 8001 8014 8016 9005 9010 9016 3003

	RAL 1004		RAL 1013		RAL 1023		RAL 1027
	RAL 2000		RAL 2002		RAL 2004		RAL 3003
	RAL 3012		RAL 3015		RAL 5003		RAL 5008
	RAL 5024		RAL 6010		RAL 6021		RAL 7001
	RAL 7011		RAL 7035		RAL 7044		RAL 8001
	RAL 8014		RAL 8016		RAL 9005		RAL 9010
	RAL 9016						

cleaning instructions

Moooki recommends using a good furniture polish and a soft cloth. Apply generously in layers to the surface and use the cloth to shine. Do not use abrasive fabrics, gently remove tough stains with warm water and a trusted multi-surface cleaner.

Packaging

Bodhi Cover 7043

H 68 cm | 26,8"

W 22 cm | 8,7"

D 22 cm | 8,7"

Colli 1/1

Product weight:

8 KG | 17,6 lb

With packaging:

9 KG | 19,8 lb

Container Table Foot 7043

H 73 cm | 28,7"

W 43 cm | 16,9"

D 43 cm | 16,9"

Colli 1/1

Product weight:

8,5 KG | 18,7 lb

With packaging:

9,5 KG | 20,9 lb

Container, New Antiques 7143

H 75 cm | 29,5"

W 45 cm | 17,7"

D 45 cm | 17,7"

Colli 1/1

Product weight:

9 KG | 19,8 lb

With packaging:

10 KG | 22 lb

packaging

Container Oval 210 top:

H 217 cm | 85.4"

W 148 cm | 58.3"

D 10 cm | 3,9"

Colli 1/1

Product weight:

KG | lb

With packaging:

KG | lb

Container Oval 260 top:

H 266 cm | 104,7"

W 177 cm | 69,7"

D 8 cm | 3,1"

Colli 1/1

Product weight:

68 KG | 149,9 lb

With packaging:

70 KG | 154,3 lb

Packaging 120x120 and Round 120 tops

HPL
H 3 cm | 1.2"
W 121 cm | 47.6"
D 121 cm | 47.6"

Wood & Linoak
H 8 cm | 3.1"
W 126 cm | 49.6"
D 126 cm | 49.6"

120 x 120
Colli 1
Product weight:
24 KG | 53 lb
With packaging:
27 KG | 59,5 lb

120 x 120
Colli 1
Product weight:
46 KG | 101,4 lb
With packaging:
49 KG | 108 lb

120Ø
Colli 1
Product weight:
18,9 KG | 41,6 lb
With packaging:
21,9 KG | 48,3 lb

120Ø
Colli 1
Product weight:
36,2 KG | 79,8 lb
With packaging:
39,2 KG | 86,4 lb

Packaging Round 140 tops

HPL
H 3 cm | 1.2"
W 141 cm | 55.5"
D 141 cm | 55.5"

Wood & Linoak
H 8 cm | 3.1"
W 146 cm | 57.5"
D 146 cm | 57.5"

Colli 1
Product weight:
25,7 KG | 56,6 lb
With packaging:
29,7 KG | 65,5 lb

Colli 1
Product weight:
49,3 KG | 108,7 lb
With packaging:
53,3 KG | 117,5 lb

Dimensions

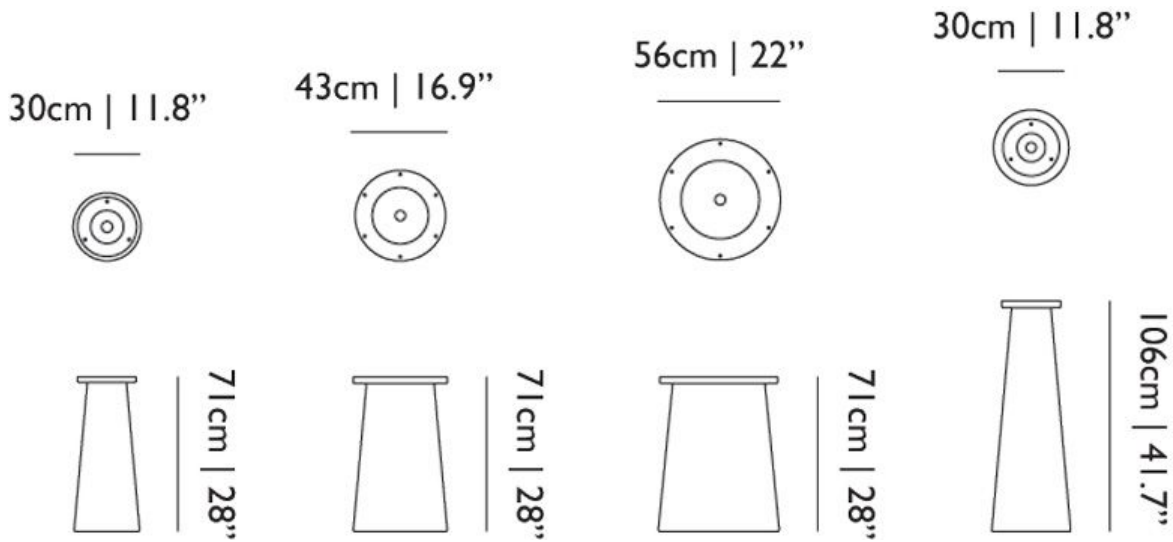

Dimensions New Antiques

