

m o o o i[®]



Container Table 7130

by Marcel Wanders

The Container Table concept is a fully versatile system that has endless composition possibilities to fit in any space. With combinations to suit your home, office or public space the Container Table can certainly exceed any requirements.

| | |
|-----------------------|---|
| Designer | Marcel Wanders |
| Year of design | 2001 |
| Material | Container Foot: PE, Top: HPL, Laquered Wood, Stained Wood, Linoleum |

The container Tops are available in the following materials and colours:



HPL, A flat panel based on thermosetting resins, homogeneously reinforced with woodfibres and manufactured under high pressure and at high temperatures:

Thickness top 1.2cm | 0.5"

Also for outdoor use

Available in white, black and light grey. The trim is always black.



Oak veneer, stained and lacquered:

Thickness top 4cm | 1.6"

For indoor use only

Available in the 6 Moooi stain colours, and 25 Moooi Ral Colours



Linoak:

Thickness top, 4cm | 1.6"

For indoor use only

The solid oak edge is available in the 6 Moooi stain colours, the linoleum centre is available in Mauve, Pewter and Nero.

The container feet are available in the following shapes and colours



Classic: White, Black



New Antiques: White, Black, Brown, Light-Grey





Bodhi Cover: Black, Cinnamon, Grey, Natural Oil, Wenge, White Wash

Container General

The container table top range all attached to the container foot in the same way. The container concept is that sand, pebbles or water can be added to the foot to give it strength and stability. Water must always be treated with an anti-algae additive to prevent the water from becoming stale. There are Hex-bolts on the underside of each table which align with equally spaced holes in the container foot.

Container Table 7130 - 7132 options

| | | | | | | FOOT | dining table |
|------------------|--------------|---------------|-----|------|--------|--|---|
| | | | | | |  <i>Classic</i> | 7130 71cm 28" x 30cm 11.8 " |
| | | | | | |  <i>Bodhi</i> | 7130 71cm 28" x 30cm 11.8 " |
| | | | | | |  <i>New Antiques</i> | 7132 71cm 28" x 32m 12.6 " |
| CONTAINER FAMILY | | Top | | | | <i>Number of feet required</i> | |
| Shape | L | W | HPL | Wood | Linoak | | |
| Rectangle | 80cm 31.5" | 180cm 70.9" | x | x | x | 2 | |
| Round | ∅ | 70cm 27.6" | x | x | x | 1 | |
| Round | ∅ | 90cm 35.4" | x | x | x | 1 | |
| Square | 70cm 27.6" | 70cm 27.6" | x | x | x | 1 | |
| Square | 80cm 31.5" | 80cm 31.5" | x | x | x | 1 | |
| Square | 90cm 35.4" | 90cm 35.4" | x | x | x | 1 | |

HPL colours

HPL tops are available in the following colours



Black

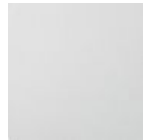

Grey

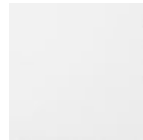

White

Linoak

The center of the Linoak top is made of linoleum, and available in the following colours. The solid oak edge is available in one of the 6 moooi stain colours.

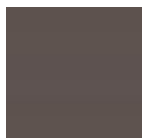

mauve



nero



pewter

Stain colours

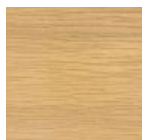

White Wash

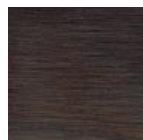

Wenge

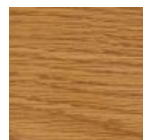

Natural Oil

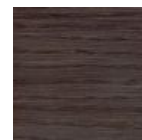

Grey

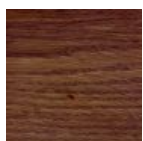

Cinnamon



Black Stained

Ral Colours

Available RAL Colours:

1004 1013 1023 1027 2000 2002 2004 3012 3015 5003 5008 5024 6010 6021 7001 7011 7035 7044 8001 8014 8016 9005 9010 9016 3003

| | | | | | | | |
|--|----------|---|----------|---|----------|---|----------|
|  | RAL 1004 | | RAL 1013 |  | RAL 1023 |  | RAL 1027 |
|  | RAL 2000 |  | RAL 2002 |  | RAL 2004 |  | RAL 3003 |
|  | RAL 3012 |  | RAL 3015 |  | RAL 5003 |  | RAL 5008 |
|  | RAL 5024 |  | RAL 6010 |  | RAL 6021 |  | RAL 7001 |
|  | RAL 7011 |  | RAL 7035 |  | RAL 7044 |  | RAL 8001 |
|  | RAL 8014 |  | RAL 8016 |  | RAL 9005 |  | RAL 9010 |
|  | RAL 9016 | | | | | | |

cleaning instructions

Moooki recommends using a good furniture polish and a soft cloth. Apply generously in layers to the surface and use the cloth to shine. Do not use abrasive fabrics, gently remove tough stains with warm water and a trusted multi-surface cleaner.

packaging

Bodhi Cover 7030

H 68 cm | 26,8"

W 18 cm | 7,1"

D 18 cm | 7,1"

Colli 1/1

Product weight:

5,5 KG | 12,1 lb

With packaging:

6,5 KG | 14,3 lb

Container Table Foot 7030

H 73 cm | 28,7"

W 31 cm | 12,2"

D 31 cm | 12,2"

Colli 1/1

Product weight:

4,5 KG | 9,9 lb

With packaging:

5,5 KG | 12,1 lb

Container, New Antiques 7132

H 74 cm | 29,1"

W 35 cm | 13,8"

D 35 cm | 13,8"

Colli 1/1

Product weight:

5 KG | 11 lb

With packaging:

6 KG | 13,2 lb

Packaging 70x 70 and round 70 tops

HPL

H 3 cm | 1.2"

W 71 cm | 27.9"

D 71 cm | 27.9"

70 x 70

Colli 1

Product weight:

8,2 KG | 17,6 lb

With packaging:

10 KG | 22 lb

70Ø

Colli 1

Product weight:

6,4 KG | 14,1 lb

With packaging:

8,4 KG | 18,5 lb

LPL

H 4 cm | 1.6"

W 71 cm | 27.9"

D 71 cm | 27.9"

70 x 70

Colli 1

Product weight:

9,3 KG | 20,5 lb

With packaging:

11,3 KG | 25 lb

70Ø

Colli 1

Product weight:

7,3 KG | 16 lb

With packaging:

9,3 KG | 20,5 lb

Wood & Linoak

H 8 cm | 3.1"

W 76 cm | 29.9"

D 76 cm | 29.9"

70 x 70

Colli 1

Product weight:

15,6 KG | 34,4 lb

With packaging:

17,6 KG | 38,8 lb

70Ø

Colli 1

Product weight:

12,3 KG | 27,1 lb

With packaging:

14,3 KG | 31,5 lb

Packaging 80x80 tops



HPL
H 3 cm | 1.2"
W 81 cm | 31.8"
D 81 cm | 31.8"
Colli 1
Product weight:
10,7 KG | 23,6 lb
With packaging:
13,2 KG | 29,1 lb

Wood & Linoak
H 8 cm | 3.1"
W 86 cm | 33.8"
D 86 cm | 33.8"
Colli 1
Product weight:
20,5 KG | 45,2 lb
With packaging:
23 KG | 50,7 lb

Packaging 90x90 and Round 90 tops

HPL
H 3 cm | 1.2"
W 91 cm | 35.8"
D 91 cm | 35.8"

Wood & Linoak
H 8 cm | 3.1"
W 96 cm | 37.8"
D 96 cm | 37.8"

90 x 90
Colli 1
Product weight:
13,5 KG | 29,7 lb
With packaging:
16 KG | 35,3 lb

90 x 90
Colli 1
Product weight:
26 KG | 57,3 lb
With packaging:
28,5 KG | 62,8 lb

90Ø
Colli 1
Product weight:
10,6 KG | 23,4 lb
With packaging:
13,1 KG | 28,8 lb

90Ø
Colli 1
Product weight:
20,4 KG | 45 lb
With packaging:
22,9 KG | 50,5 lb

Packaging 180x80 tops

HPL
H 3 cm | 1.2"
W 181 cm | 71.3"
D 81 cm | 31.9"
Colli 1
Product weight:
24 KG | 53 lb
With packaging:
29 KG | 64 lb

Wood & Linoak
H 8 cm | 3.1"
W 186 cm | 73.2"
D 86 cm | 33.9"
Colli 1
Product weight:
46,1 KG | 101,6 lb
With packaging:
51,1 KG | 112,7 lb

Dimensions

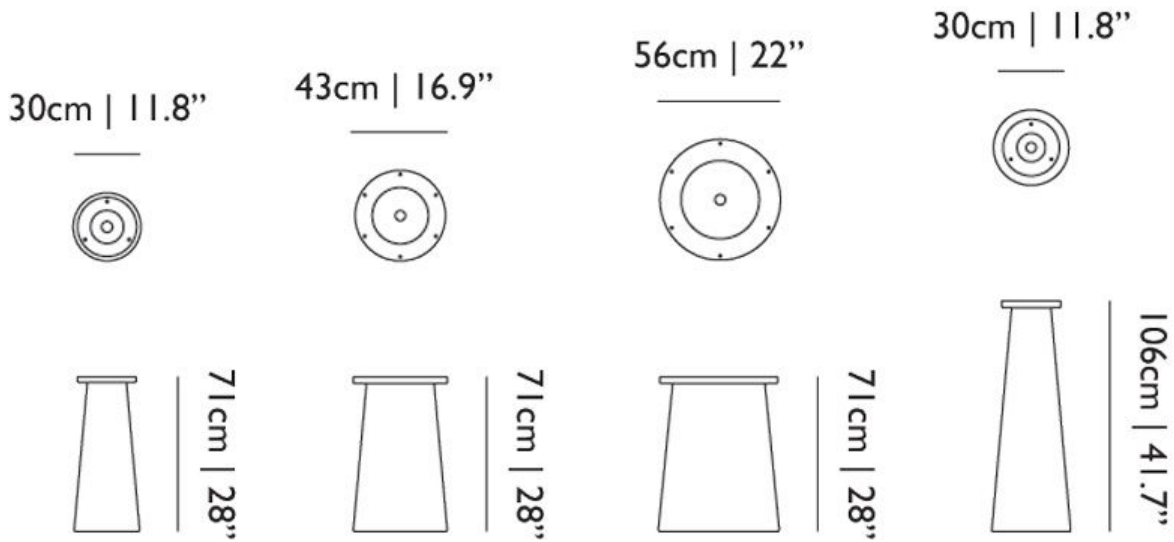

Dimensions New Antiques

